

YOUNGMAN

INNOVATIVE WORK AT HEIGHT SOLUTIONS

Use and Care Instructions:
Youngman Telescopic Loft Ladder

Models:
2.6m and 2.9m

Safety

Please ensure you read the Safety section in this manual starting on **page 4** before installing or using the equipment. Your safety and that of others is important.



Introduction

The Youngman Telescopic Loft Ladder is manufactured in aluminium with an anodised finish. It is built to withstand the toughest handling and working conditions. Suitable for home and commercial use. Spare parts are readily available.

We recommend you take time and read these instructions. They contain full installation details and describe how to deploy the ladder and how to store it after use to ensure you get the very best performance from your purchase.

Keep these instructions in a safe place for future reference.

For more information about the Youngman Telescopic Loft Ladder and other products, please visit our website www.youngmangroup.com



Youngman Group Ltd
The Causeway, Maldon, Essex, CM9 4LJ, UK
t: +44 (0)1621 745900
e: sales@youngmangroup.com

Contents

Introduction	1
Safety	1
In the Box	2
Important Safety Information	3
Safety Considerations	3
Servicing and Spare Parts	3
Main Features	4
Loft Ladder Components Identified	5
Step 1: To Install the Loft Ladder	6
Step 2: To Close and Stow the Loft Ladder	13
Step 3: To Open the Loft Ladder	14
Specifications	15
Warranty	16

In the Box

Carefully remove your Youngman Telescopic Loft Ladder and fitments and accessories from the box it arrived in. It is recommended that you retain this packaging should the item need to be returned under warranty. The following items are supplied:

- Ladder (x1)
- Mounting brackets (x2)
- Swivel arms (2)
- Hinge swivel pins (x2)
- Ladder sub-frame carrier bar (x1)
- Ladder sub-frame carrier tubes (x2) - supplied attached to mounting brackets
- Springs (x2)
- The User Manual (this publication)
- Telescopic pole with hook
- Mounting bracket fixing screws (x8)

These items are shown in the illustration opposite.

Important Safety Information

Warning

For your safety, please read all the safety instructions in this Manual before using the Youngman Telescopic Loft Ladder.

Safety and quality is of paramount importance when manufacturing Youngman products.

Important

Read these instructions before installing the Youngman Telescopic Loft Ladder.

Important

Install the Youngman Telescopic Loft Ladder according the instructions given in this Manual and on the labels affixed to the equipment.

Safety Considerations

General

- Do not install or use the Youngman Telescopic Loft Ladder if damaged in any way.
- Never exceed the maximum load of 150 kg.
- Never operate any of the red buttons while on the ladder or allow anyone else to operate the buttons while it is in use.

Cleaning

- Do not use any abrasive or chemical solvents.
- Periodically clean with a soft damp cloth. We recommend occasionally spraying with a silicon spray.

How to Dispose of this Product

When the unit has reached the end of its life, contact your local council regarding available recycling or disposal options.

Servicing and Spare Parts

When the unit has reached the end of its life, contact your local council regarding available recycling or disposal options.

Main Features

The main features of the Youngman Telescopic Loft Ladder are listed below:

- There are two models each adjustable to three lengths for optimum usability.
See the table below for details.
- Manufactured in anodised Aluminium with steel fixing brackets and fitments.
- Fitted with rubber feet for safety and protection of the floor.
- Closes down to a small volume and fits into the smallest of spaces.
See table below.
- The loft hatch must be converted so that the door opens downwards.
- Permanently fitted in the loft.
- Allows loft hatch to close when stowed away.
- Very easy to operate and use.

Loft Ladder Details

Floor to Floor Height	Model Number	Minimum Hatch Size (W x L)	Overhang (Distance Behind the Joist)
217 - 261cm	TL24	510 x 600cm	235mm
243 - 288 cm	TL30	510 x 600cm	235mm

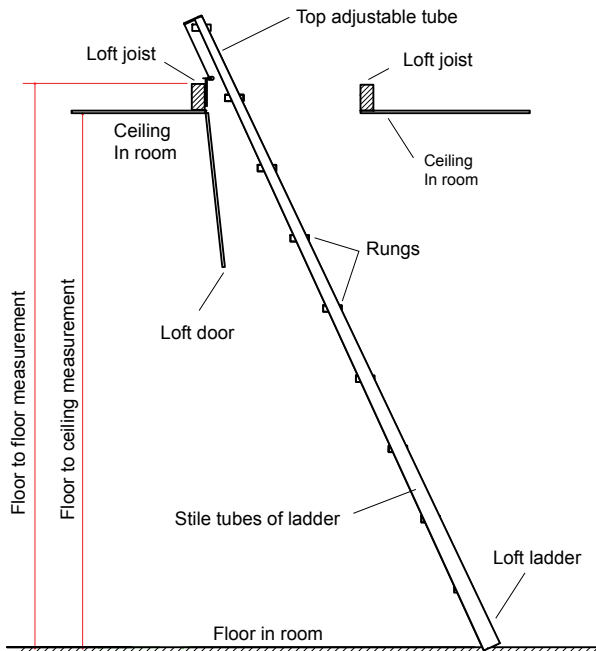

Loft Ladder Components Identified



Parts	Components
1	Ladder
2	Mounting brackets (x2)
3	Swivel arms (x2)
4	Hinge swivel pins (x2)
5	Ladder sub-frame carrier bar (x1)
6	Ladder sub-frame carrier tubes (x2)
7	Springs (x2)
8	Telescopic pole with hook (x1)
9	Bracket fixing screws (x8)
10	Instructions

Step 1: To Install the Loft Ladder

Installation Consideration

The following points should be considered before installing the Loft Ladder.

Loft Hatch

The loft hatch must be downward opening. It may be necessary to refit your loft hatch door so that it opens downwards so that the hatch when open hangs down behind the ladder when it is deployed.

Loft Opening

It is recommended that the loft ladder is installed so that it is orientated parallel to the longer side of the opening. This will give the user more comfortable access to the loft and will be easier for the user to take items into the loft.

Secure Fixing

The two fixing brackets supplied must be attached to a secure part of the loft structure such as a ceiling joist or sound timber bridging and securely fastened to the joists.

Footprint

When the ladder is opened there should be enough space available at the base of the ladder for a person to easily and safely get onto and climb the ladder.

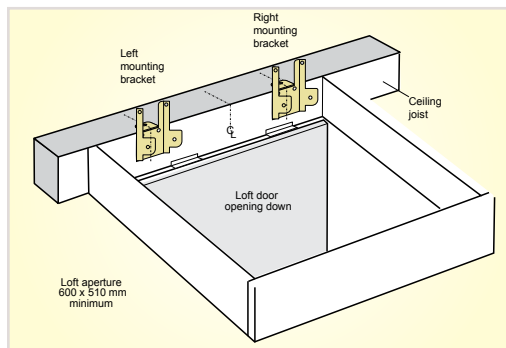

Tools

You will need the following tools and materials: Pencil, set-square and measuring tape (mm) for marking out.

A drill and a 4mm drill bit for drilling the bracket fixing holes and a Posidrive screwdriver for tightening the eight bracket fixing screws.

Strong string to extend the springs during installation.

Step 1: To Install the Loft Ladder

Installation

Marking Out

1.1 Measure and draw the 'centre line' on the ceiling joist midway across the width of the loft opening where the mounting brackets will be fitted, Fig 1.1.

Measure 188 mm either side of this line and draw a vertical line at these points greater than 90 mm long to mark the mounting bracket centre lines.

1.2 Refer to Fig 1.2 and Fig 1.3. The brackets are supplied with their ladder sub-frame carrier tubes fitted. Note that these brackets are 'handed', left bracket and right bracket.

Take the first bracket and place it on the mounting board so that it is placed over the bracket centre line and slide it until the lower screw hole is centred on this line. Mark the centre point of this hole.

Fixing the Brackets

1.3 Remove the bracket and drill a 4mm diameter hole at the position just marked.

Fix the bracket using one of the fixing screws supplied. Similarly drill the other three holes (one on top) and screw in the other screws. Repeat for the other bracket, see Fig 1.3.

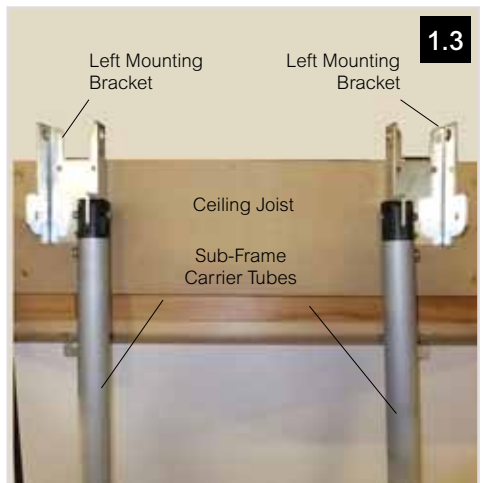
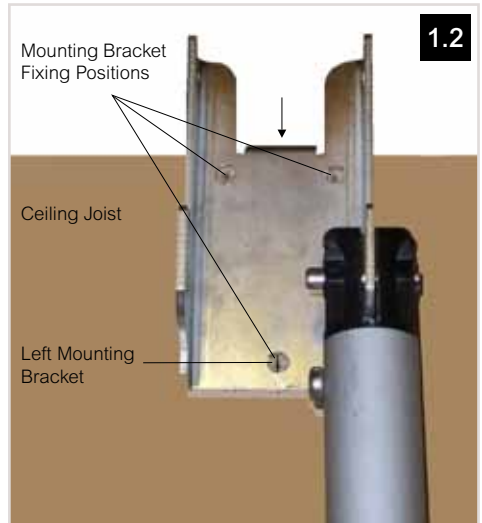
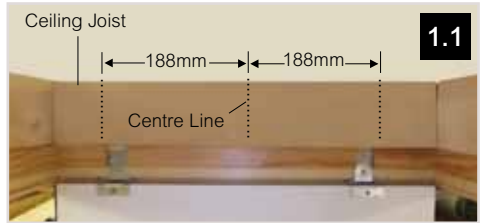

Step 1: To Install the Loft Ladder

Swivel Arm

1.4. Place the Right Swivel arm in position on the Right Mounting bracket and align their holes, Fig 1.4.

1.5. From the outer edge, guide the Hinged swivel pin through the arm and bracket holes and push in completely, Fig 1.5.

Repeat this procedure with the Left Swivel arm and the Left mounting bracket using the other Hinged swivel pin.

1.6. The installation will now be at the stage shown in Fig 1.6.

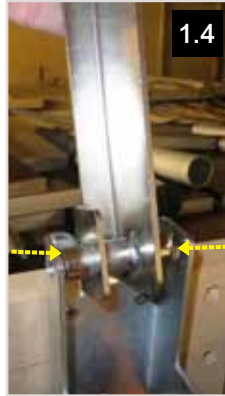

Attaching the Springs

1.7. Slide the Ladder sub-frame carrier bar into the hole in one of the sub-frame carrier tubes, see Fig 1.7. Now slide the two spring eyelets onto the bar.

1.8. Slide the other end of the carrier bar into the corresponding hole on the other sub-carrier tube, Fig 1.8.

There is groove near each end of the bar for the purpose of holding the spring in place when installed, see Fig 1.8 (inset). Locate each spring in these grooves.

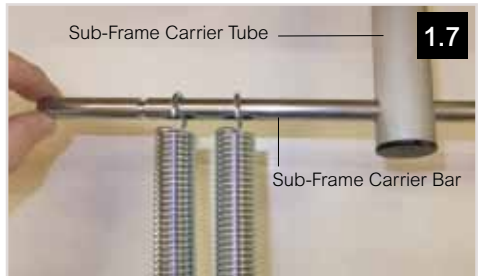

Step 1: To Install the Loft Ladder

Extending the Springs

The next step is to anchor the free end of the spring to its anchor point on the hinged swivel pin.

Lay the swivel arms back so they are horizontal. Hook a loop of strong string to the end of the spring.

1.9. Lift the sub-frame carrier tube above the horizontal and pull the string to extend the spring so that it reaches and clips on to the hinged swivel pin, see Fig 1.9 and inset for close-up of spring on the pin. Remove the string.

1.10. Now slide the spring eyelet along the pin so that it locates in the groove on the pin, see Fig 1.10. Repeat for the other spring.

1.11. The installation will now be at the stage shown in Figure 1.11.



Step 1: To Install the Loft Ladder

Warning

Be very careful when carrying out the next stage as there is no ladder to stop the sub-frame from swinging forward with considerable force if it is moved inadvertently.

1.12. Pull down on the sub-frame carrier bar until it touches against its stop.

1.13. The tensioned springs will hold it in this position, see Fig 1.13.

Adjusting the Ladder Length

1.14. The ladder length can be extended by 15cm or 30cm from its minimum length to best suit your floor-to-floor height.

The adjustment tube is shown in Fig 1.14:

- a.** Minimum length - no extension
- b.** Extended by 15cm
- c.** Extended by 30cm

Remove the two bolts from the endcaps and have them ready to fix the swivel arms to the ladder at step 1.21.



Step 1: To Install the Loft Ladder

1.15. On the side you are adjusting first (left shown here), depress the red button on the top rung to disengage the locking bolt from the top stile.



1.16. Keep the button pressed and rotate the stile until the required extension position is reached and then release the button, see Figs 1.17 and 1.18a and 1.18b.



1.17. The set extension is indicated by the orientation of the grooves on the end cap, see Fig 1.16 and Fig 1.17.

In Fig 1.17, the setting shows 'no extension'.

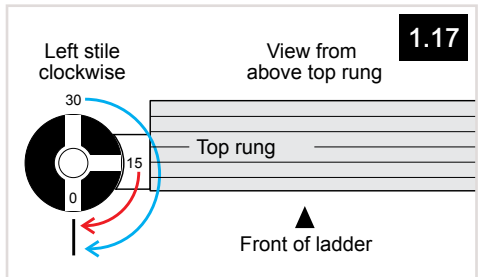

1.18a. Shows the end cap rotated 90 degrees clockwise to the 15 cm extension position.

1.18b. Shows the end cap rotated 180 degrees clockwise to the 30 cm extension position.

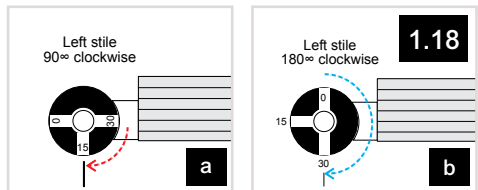

1.18c and d. Now carefully pull the stile upwards until the stile is locked in its extended position.

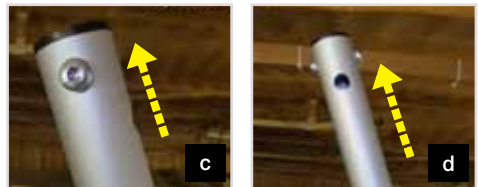

Repeat the same setting on the right-hand top stile from step 1.15. Note that this stile must be rotated 90 degrees and 180 degrees CCW for 15 and 30 cm extensions respectively.

Step 1: To Install the Loft Ladder

Extend the Ladder

1.19. Fully extend the ladder until all rungs are locked. This is indicated in the illustration below by the red buttons being extended.

Important

Ensure that all the red buttons on the underside of the rungs are in the locked position, see above right.

It is **dangerous** to climb or attempt to climb the ladder when the rungs are not locked, see right.

1.20. Stand the ladder on the floor below the loft and rest the ladder against the sub-frame with the top of the ladder close to the swivel arms. Climb the ladder and enter the loft to gain access the top of the ladder.

Screw to the Swivel Arms

1.21a. Align the holes in the swivel arm with the threaded hole in the top end of the ladder.

1.21b. Finger tighten the bolt supplied.

1.21c. Use an Allen key to tighten this bolt to securely fix the swivel arm to the ladder ensuring the location pin engages with the groove in the endcap. Repeat for the other side of the ladder.

1.21d. Shows both sides of the ladder fastened to the swivel arms.

Installation is now complete.

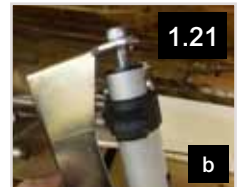
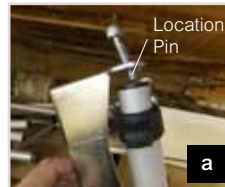

Step 2: To Close and Stow the Loft Ladder

2.1. Depress the two red buttons on the underside of rung 2 to unlock the rung, see Fig 2.1 then push the rung upwards in the direction of the arrows.

You can now release your fingers from the buttons and continue to raise the rung.

When the rung 2 touches rung 3, it will push in the red buttons and unlock rung 3. Continue to raise rung 2 to now move both rungs up together.

2.2. Grip the lower stiles and push up to unlock and close more rungs in the same way. If you can now place the stowage bracket (see Fig 2.4) onto the sub-frame carrier bar, then do so and ignore paragraph 2.3.

2.3. Insert the plain end of pole into the holes in rung 1 and rung 2 and lift up the ladder to close all the rungs and sit the stowage bracket located on the rear of the rung 1, onto the sub-frame carrier bar.

2.4. Use the hook end of the pole and hook onto the carrier bar to raise the ladder. During this operation the springs will pull the ladder into a horizontal position.

Remove the pole and close the loft hatch.

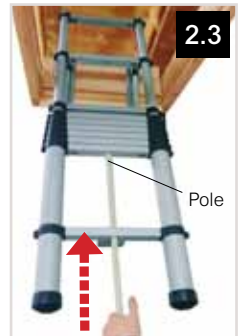
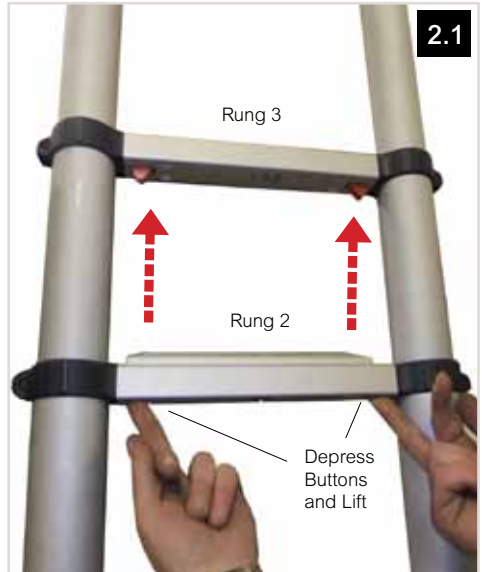

Step 3: To Open the Loft Ladder

Open the Loft Hatch

3.1. Use the hook end of the pole to pull down on the Ladder sub-frame carrier bar to swivel the ladder to the vertical position.

If at this point, the ladder can be reached by hand then ignore paragraph 3.2 and unhook from the carrier bar and lower to the floor.

3.2. Pass the plain end of the pole through the hole in rung 1 and rung 2. Push the pole up to un-hook the ladder stowage bracket on the rear of rung 1 from the sub-frame carrier bar and carefully lower the ladder.

Remove the Pole

3.3. Grip the lower stiles of the ladder and carefully pull it down and extend the ladder. Make sure all the rungs are locked (indicated by the red buttons being extended below the rungs).

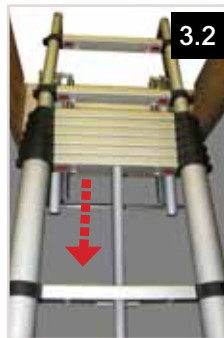

Specifications

Specifications	
Maximum Load	150 kg
Dimensions	
Model No TL24	
Floor-to Floor-height	217cm - 261cm
Angle of ladder	65 deg 75 deg
Footprint	/
Max height setting	123 cm 74 cm
Mid height setting	116 cm 70 cm
Min height setting	111 cm 67 cm
Model No TL30	
Floor-to-Floor height	243 cm - 288 cm
Angle of ladder	65 deg 75 deg
Footprint	/
Max height setting	135 cm 81 cm
Mid height setting	129 cm 78 cm
Min height setting	123cm 74cm
Construction	Aluminium

Important

The Manufacturer and/or their recognized agents, directors, employees or insurers will not be held liable for consequential or other damages, losses or expenses in connection with, or by reason of, or the inability to use the Youngman Telescopic Loft Ladder for any purpose.

Youngman Telescopic Loft Ladder User Manual

All rights reserved. No part of this publication may be reproduced, transmitted, transcribed, translated or stored in a retrieval system in any form by any means without the written permission of Youngman® Limited. Technical details contained in this publication are correct for the equipment model numbers supplied. The Instruction and Reference Manual will be revised as necessary for subsequent revisions to the equipment. This information will also be published on our website. Copyright Youngman® 2012.

Warranty

Your Youngman Telescopic Loft Ladder is covered by a **12 month warranty**.

The Company undertakes to replace or repair, free of charge, any defect which the Company considers to be due to faulty workmanship or material within 12 months of the sale date, except for:

- Defects arising from neglect, misuse or unauthorised modifications.
- Damage caused by abuse, misuse, dropping or other similar damage caused by or as a result of failure to follow transportation, storage, loading or operation, instructions.
- Alterations, additions or repairs carried out by persons other than the Manufacturer or their recognized distributors.
- Transportation or shipment costs to and from the Manufacturer or their recognized agents, for repair or assessment against a warranty claim, on any or component.
- Materials and/or labour costs to renew, repair or replace components due to fair wear and tear.
- Faults arising from the use of non-standard or additional parts, or any consequential damage or wear caused by the fitting or use of such parts.

Youngman Group Ltd

The Causeway, Maldon, Essex

CM9 4LJ, United Kingdom

t: +44 (0)1621 745900

e: sales@youngmangroup.com