

Nokia BPM

Blood Pressure - Heart rate Measurement Installation and Operating Instructions



Table of Contents

Minimum Requirements.....	4
Smartphone or Device.....	4
OS version.....	4
Nokia BPM Description.....	5
Overview.....	5
Box Contents.....	5
Product Description.....	6
Setting up my Nokia BPM.....	7
Installing the Nokia Health Mate® app.....	7
Using my Nokia BPM.....	16
Taking a measurement.....	19
Understanding the results.....	21
Managing my data.....	28
Dissociating my Nokia BPM.....	30
Cleaning and Maintenance.....	31
Cleaning my Nokia BPM.....	31
Changing the Batteries.....	31
User Guide Copyright.....	32
Legal Notice.....	32
Medical Device.....	32
Personal Data.....	32
Safety Instructions.....	33
Use and Storage.....	33
Safety.....	33
Service and Maintenance.....	33
Specifications.....	34
Document Release Overview.....	35
Warranty.....	36

Important Notice



By using your Nokia BPM you expressly agree to the Nokia Services Terms and Conditions available on our [website](#).

Minimum Requirements

Smartphone or Device

An iOS or Android device (with operational Bluetooth and Wi-Fi or 3G/4G) is required to:

- Download the Nokia Health Mate® app
- Set up your Nokia BPM
- Access your data

For device compatibility information, refer to "[Specifications](#)" on page 34.

OS version

You need iOS 7 (or higher) or Android 4.0 (or higher) to install and run the Nokia Health Mate® app.

Nokia BPM Description

Overview

The Nokia BPM is a medical device that allows you to accurately track and monitor your blood pressure and heart rate measurements.

Thanks to the cuff oscillo metric method, you simply have to wrap the cuff of the Nokia BPM around your arm and press the button to get a measurement. Your blood pressure and heart rate measurements are then sent to the Nokia Health Mate® app automatically.

The Nokia Health Mate® app allows you to easily view the history of your measurements. You can also share data with your family and doctor.

Box Contents

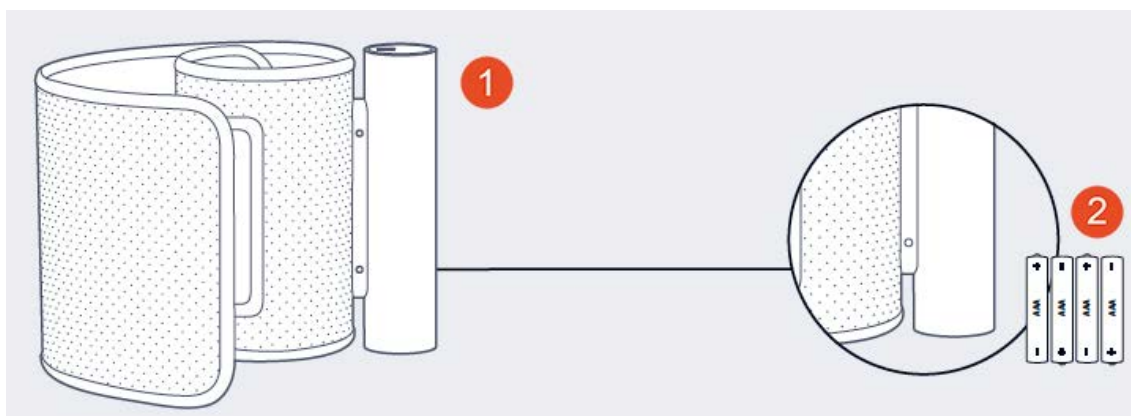

(1) Wireless Blood Pressure Monitor

(2) AAA alkaline cells (already inserted)

Note: The Withings version of the blood pressure monitor has one USB adapter in the box.

Product Description

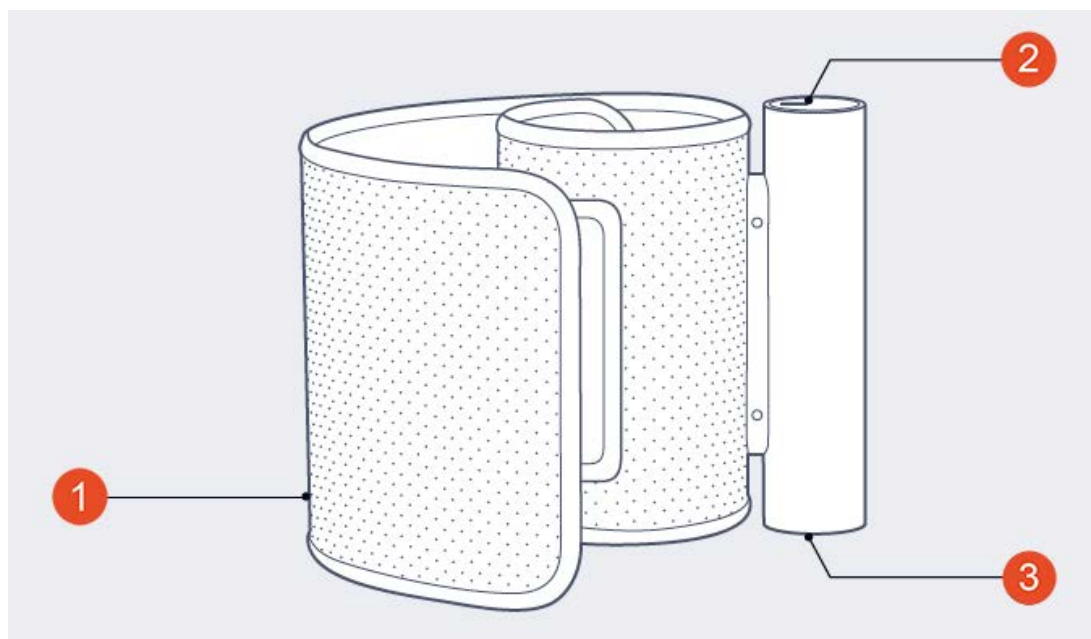

(1) Button

(2) Cuff

(3) Battery cover

Note: The Withings version of the blood pressure monitor has one USB port.

Setting up my Nokia BPM

Installing the Nokia Health Mate® app

If the Nokia Health Mate® app is not already installed on your device, perform the following steps:

1. Type healthapp.nokia.com in your device's web browser.
2. Tap **Download** on the App Store or on the Play Store.
3. Tap **Get**.
The installation process starts.

When a new version of the Nokia Health Mate® app is available, you will automatically be prompted to update it.

Installing my Nokia BPM

I'm new to Nokia Health Mate®

If you don't already have a Nokia Health Mate® account, you have to create one in order to set up and use your Nokia BPM.

If you already have an account, refer to "[I already have a Nokia Health Mate® account](#)" on [page 12](#).

To install your Nokia BPM, perform the following steps:

1. Open the Nokia Health Mate® app.
2. Tap **Get started**.



3. Tap **Start installing my device.**



4. Tap **Blood Pressure Monitors.**

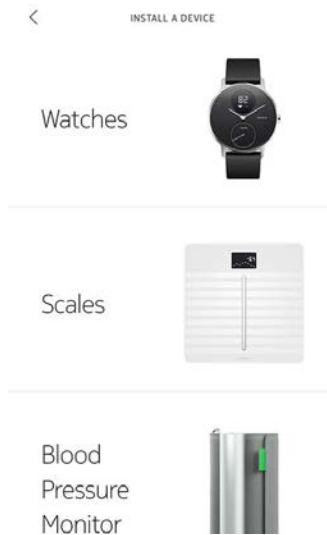

5. Tap **Nokia BPM.**



6. Tap **Install.**

7. Press the button of the Nokia BPM.

CANCEL

Wake up your BPM

Push the button to wake up your BPM

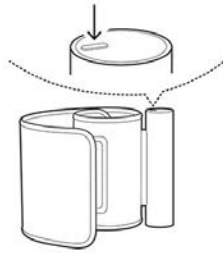

The LED of the Nokia BPM lights up blue and starts blinking.

8. Tap **Next** in the app.

9. Tap **Install**.

10. Tap **Pair** (iOS only).

CANCEL

Pair your BPM with your phone



PAIR

11. Tap **Pair** (iOS only).

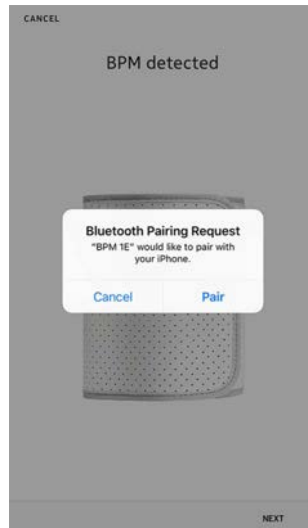

12. Tap **Next**.



13. Enter your email and password. Tap **Create**.



14. Enter your first name, surname and birthday.

15. Select your gender and enter your height and weight. Tap **Next**.

16. Tap **Change the avatar** if you want to change it.

17. Tap **Next**.

You have the possibility to add a family member if you want to.

The Nokia BPM is updating and restarting.

18. Tap **Done**.

You're all set!



DONE

19. Tap **Start**.

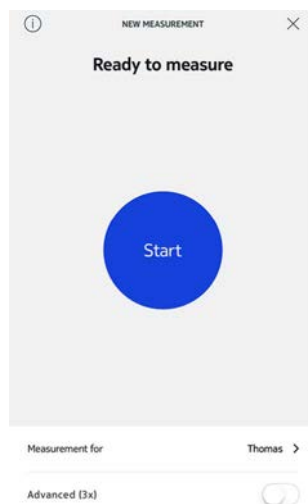

20. Tap **Done** at the end of the measurement.



If you want to take another measurement, tap on **Try again**.

I already have a Nokia Health Mate® account

If you already have a Nokia Health Mate® account, you can get started on the installation process. To do so, perform the following steps:

1. Open the Nokia Health Mate® app.
2. Log in to your account, if you already have one, or create one.
3. Tap **Devices**.
4. Tap **+**.

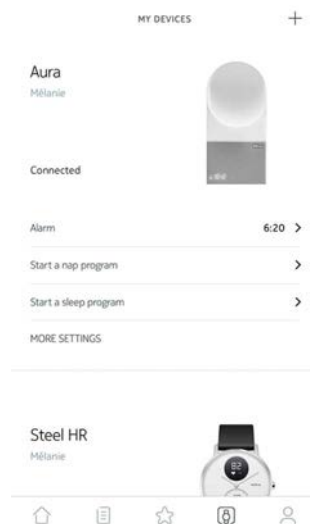

5. Tap **Blood Pressure Monitors.**

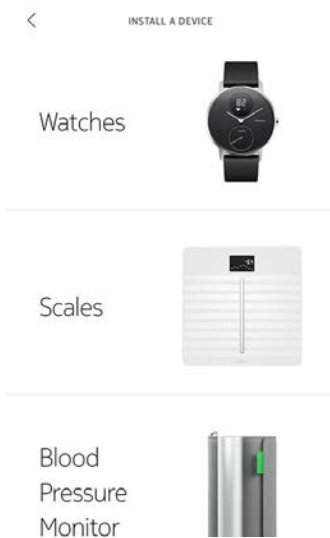

6. Tap **Nokia BPM.**



7. Tap **Install.**

8. Press the button of the Nokia BPM.

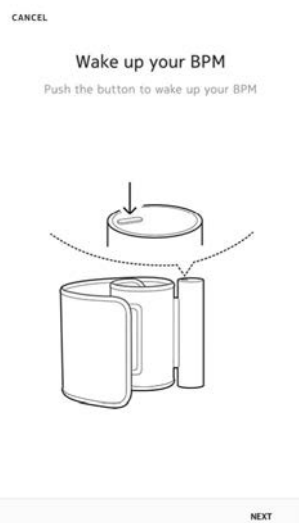

The LED of the Nokia BPM lights up blue and starts blinking.

- 9. Tap **Next** in the app.
- 10. Tap **Install**.
- 11. Tap **Pair** (iOS only).

CANCEL
Pair your BPM with your phone



- 12. Tap **Pair** (iOS only).

PAIR

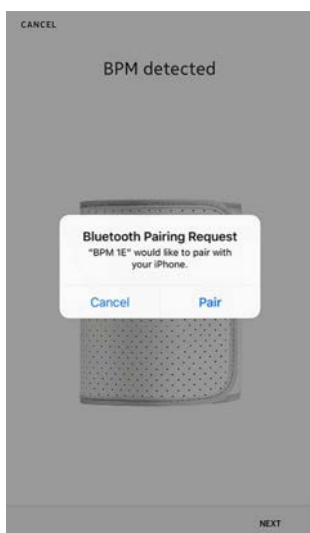

- 13. Tap **Next**.

CANCEL
BPM connected



NEXT

14. Tap **Done**.

You're all set!



DONE

15. Tap **Start**.

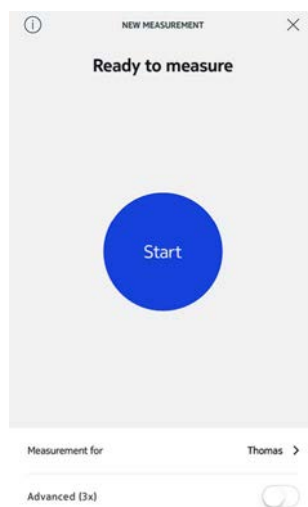

16. Tap **Done** at the end of the measurement.



If you want to take another measurement, tap on **Try again**.

Positioning myself before and during the measurement

Make sure you follow these guidelines when taking a measurement. Failing to do so may lead to inaccurate results or cause the measurements to fail.

1. Sit down in a comfortable position.

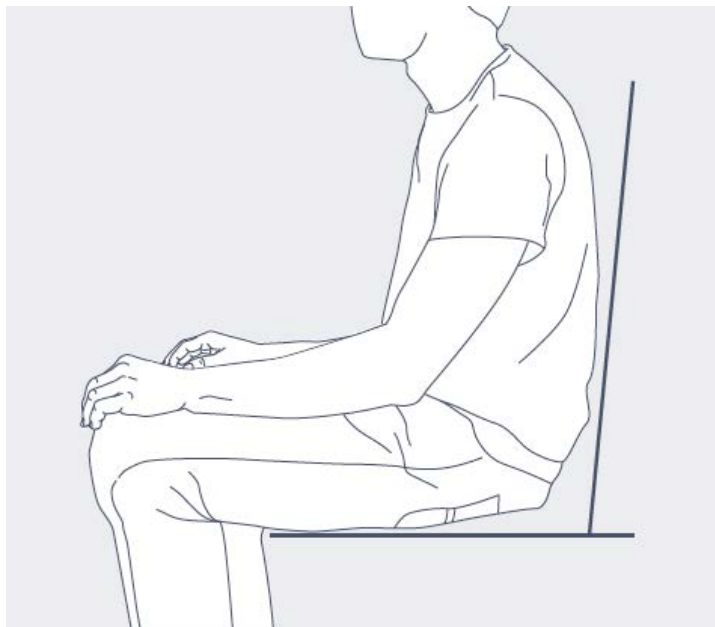

2. Make sure you rest for five minutes before taking a measurement.
3. Wrap the cuff around your arm.
The metal tube should be positioned against your inner arm, 2 cm above your elbow.

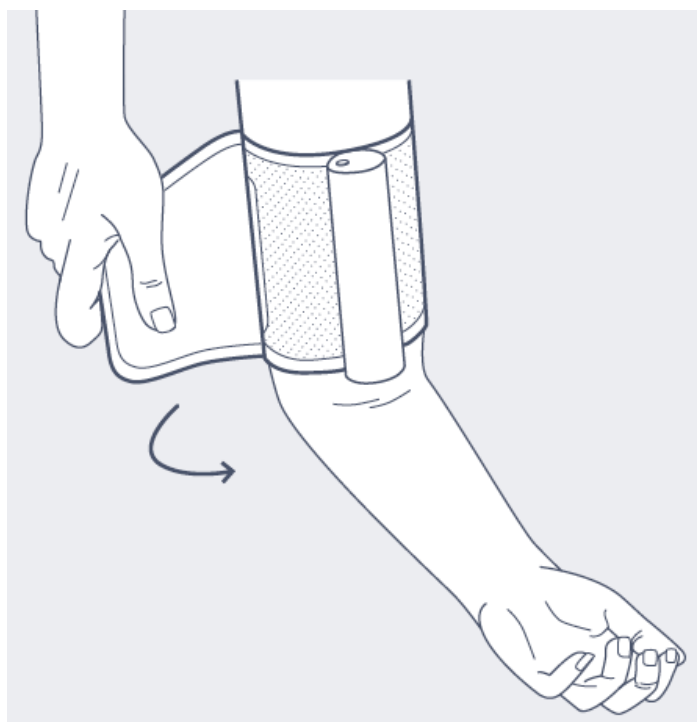

4. Place your arm on a table and level with your heart.
Make sure the cuff is not too loose or too tight. You should be able to insert two fingers between the cuff and your arm.

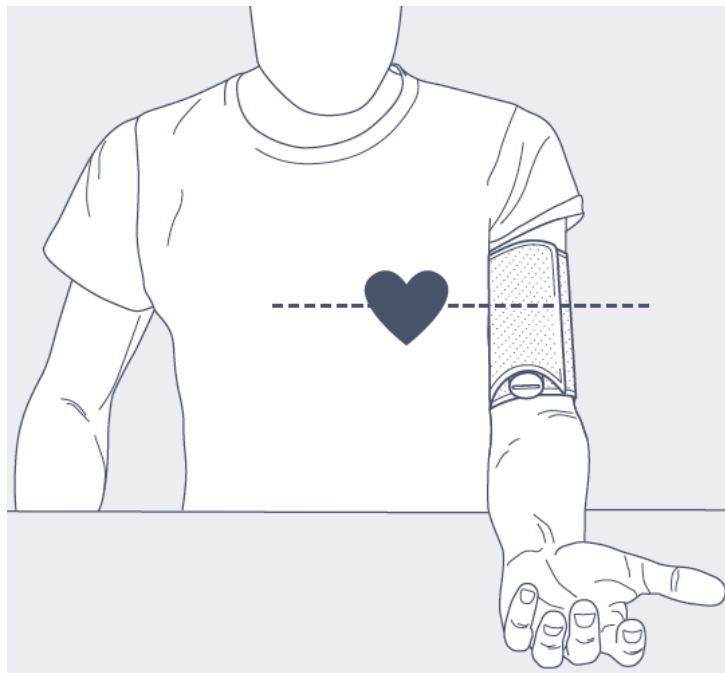

5. Turn on your Nokia BPM.
The Nokia Health Mate® app starts automatically.

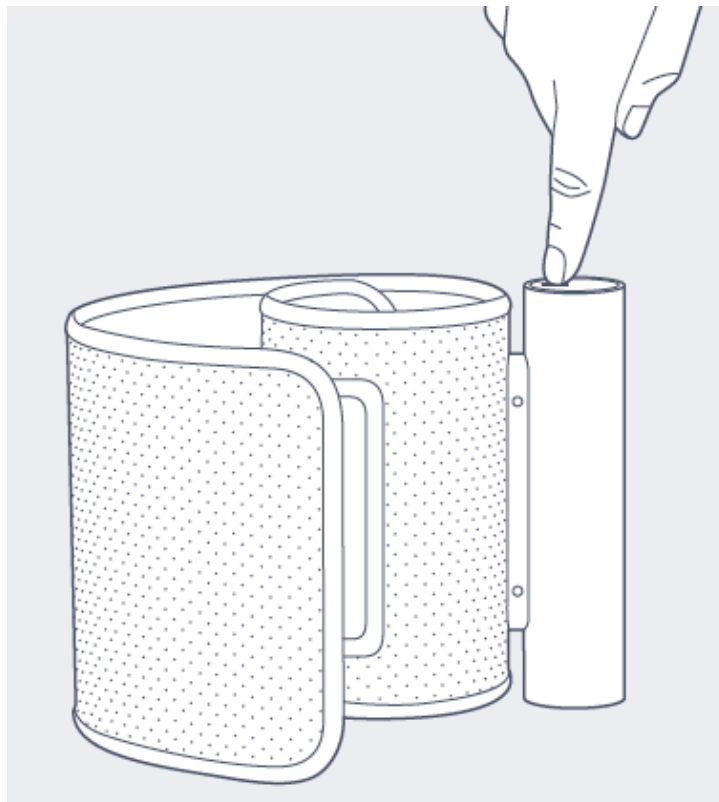

6. From the app, press the **Start** button to launch the measurement.

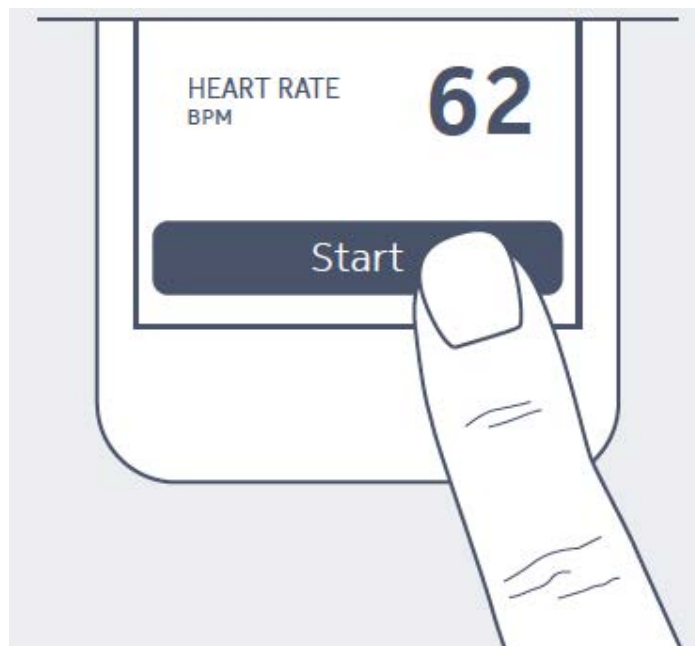

Taking a measurement

To take a measurement, perform the following steps:

1. Position the Nokia BPM.
For more information on how to position the Nokia BPM, refer to "[Positioning myself before and during the measurement](#)" on page 18.
2. Turn on the screen of your phone.
3. Press the button of the Nokia BPM.
The Nokia Health Mate® app launches.
4. Tap **Next** to pass through the tutorial.



At this point, you have the possibility to take an automatic measurement. This option allows you to take three consecutive measurements, and to obtain the average of the three measurements.

5. Tap the user name below **New measurement for** if you want to take an anonymous measurement or take a measurement linked to another user profile.
6. If you want to take an automatic measurement, tap **Advanced (3x)** (Automatic mode).

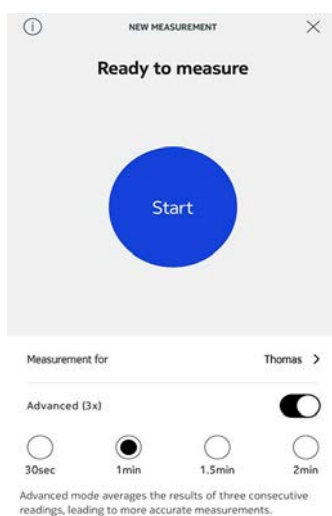

7. Tap **Start**.

Make sure you stay as still as possible and avoid talking during the measurement. Any movement may impact your results.

8. Tap **Done** at the end of the measurement.



Understanding the results

US and Canada

Compare your results to the table below to understand them better.

CATEGORY	SYSTOLIC (mmHg)	DIASTOLIC (mmHg)
Normal	< 120	< 80
Elevated	120 - 139	< 80
High blood pressure (Hypertension) Stage 1	130 - 139	80 - 89
High blood pressure (Hypertension) Stage 2	140 or higher	90 or higher
Hypertensive crisis (emergency care needed)	180 and higher	120 and higher

This classification is taken from the 2017 guidelines of the American Heart Association. This classification is based on the values of seated blood pressure measured in a doctor's office or hospital by a healthcare professional.

International guidelines suggest that the following blood pressure readings obtained by self-measurement (measurement taken at home) indicate high blood pressure:

- Systolic blood pressure ≥ 120 mmHg
- Diastolic blood pressure ≥ 80 mmHg

The color code of this classification is from the article “CoCo trial: Color-coded blood pressure Control, a randomized controlled study”.

European Union

Compare your results to the table below to understand them better.

CATEGORY	SYSTOLIC (mmHg)	DIASTOLIC (mmHg)
Optimal	< 120	< 80
Normal	120 - 129	80 - 84
High Normal	130 - 139	85 - 89
Grade 1 Hypertension	140 - 159	90 - 99
Grade 2 Hypertension	160 - 179	100 - 109
Grade 3 Hypertension	≥ 180	≥ 110
Isolated systolic hypertension	≥ 140	< 90

This classification is taken from the 2017 guidelines of the American Heart Association. This classification is based on the values of seated blood pressure measured in the office or hospital by a healthcare professional.

International guidelines suggest that the following blood pressure readings obtained by self-measurement (measurement taken at home) indicate high blood pressure:

- Systolic blood pressure ≥ 130 mmHg
- Diastolic blood pressure ≥ 85 mmHg

The color code of this classification is from the article “CoCo trial: Color-coded blood pressure Control, a randomized controlled study”.

Getting Insights

Hy-Result is a medically validated protocol that allows you to test your hypertension from home and share the results with your doctor. It also gives you a complete and precise diagnostic about your blood pressure.

While it is a chargeable option, you can use it as many times as you'd like after the purchase.

Purchasing Hy-Result (iOS only)

To get the Hy-Result function, perform the following steps:

1. Open the Withings Health Mate™ app.
2. Tap **Programs**.
3. Tap **Healthier Heart**.

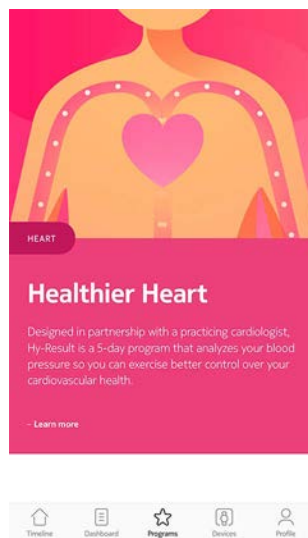

4. Tap **Join**.

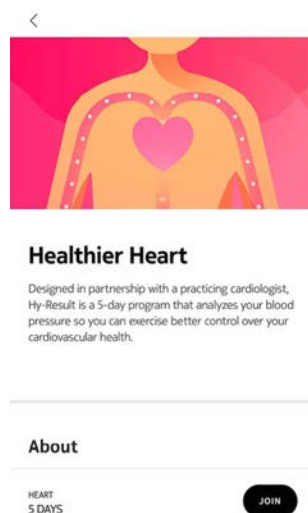

You'll then have to enter your Apple ID and password to validate the purchase.

Setting Hy-Result (iOS only)

Before starting the protocol, you'll have to fill in a form with various information about your health. Please note that none of this information will be shared with Withings or anyone else. Furthermore, this information will only be accessible locally on your iPhone.

Once the purchase is validated, you can start setting Hy-Result. To do so, perform the following steps:

1. Open the Nokia Health Mate® app.
2. Tap **Programs**.



3. Tap **Hy-Result**.

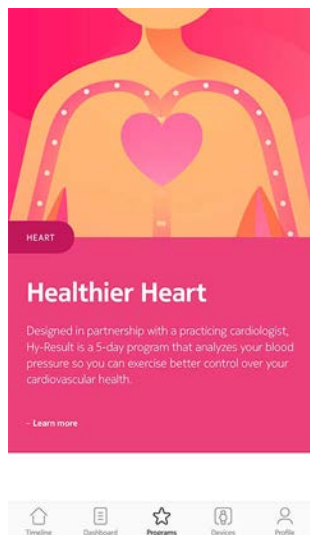

4. Tap **Join**.

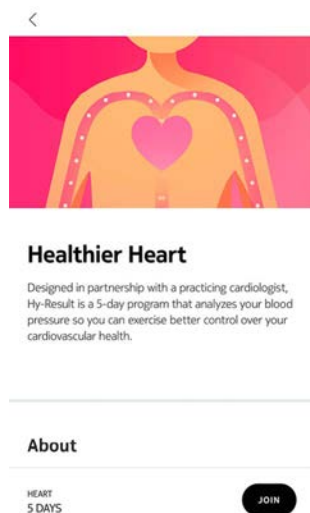

5. Set reminders to make sure you don't forget to take your measurements.

6. Fill in the form.

7. Tap **OK**.

8. Tap **Done**.

The protocol will start the next day.

Using Hy-Result (iOS only)

The Hy-Result protocol takes place over five days. During these five days, you'll have to enter three measurements per half-day (ten half-days in total). You can select one of three ways to enter these measurements:

- Enter three measurements manually
- Take three separate measurements using your Nokia BPM
- Take an automatic measurement using your Nokia BPM

To get the results, you can't miss more than two half-days of measurements. If you miss any more than that, you'll have to start the protocol over from the start.

Make sure you don't log out of the Nokia Health Mate® app for the entire duration of the Hy-Result protocol. If you do, you'll have to start the protocol over from the start, as your data is only stored locally on your iPhone.

Viewing the results

Once you have completed the Hy-Result protocol, a PDF will be created with results, containing the following information::

- Your average blood pressure with a color code
- An analysis of your hypertension, validated by medical research
- A PDF report that you can share with your doctor

You will have the opportunity to save this PDF, but for privacy reasons, if you do not save the PDF it will be deleted and you will lose your results. Note that the Hy-Result feature may be used as many times as you would like after purchase.

Viewing the history of my measurements

As soon as you take your blood pressure and your heart rate, your measurements are sent to the Nokia Health Mate® app.

To see detailed about your measurements, and see your full history, you have to check your data on the Health Mate® app.

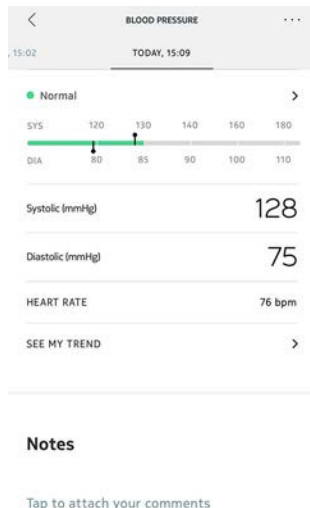

You can access your data by tapping any blood pressure or heart rate measurement item in your Timeline.

Sharing my data with Apple Health

The Nokia Health Mate® app can share the following data with Apple Health:

- Diastolic Blood Pressure
- Heart Rate
- Systolic Blood Pressure

To link your accounts, perform the following steps:

1. Open the Health Mate app.
2. Tap **Profile**.
3. Tap **Health**.

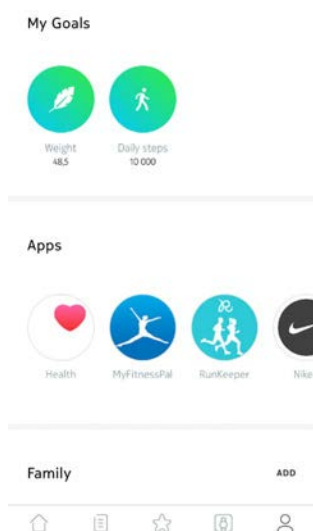

4. Select the data you want to share with Apple Health.



5. Tap **Allow**.

Deleting data

You have the possibility to delete your heart rate and blood pressure measurements from the Nokia Health Mate® app. To do so, perform the following steps:

1. Open the Nokia Health Mate® app.
2. Swipe the value which you want to delete measurement.



3. Tap **Delete**.

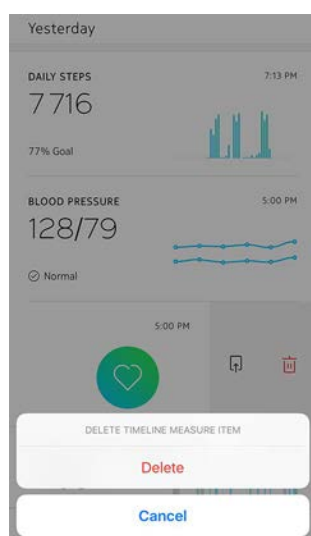

Dissociating my Nokia BPM

If you want to stop using your Nokia BPM, you have to dissociate it from your account first.



Dissociating your Nokia BPM will not remove any of the data that was synced from the Nokia Health Mate® app.

To dissociate your Nokia BPM, perform the following steps:

1. Open the Nokia Health Mate® app.
2. Go to **Devices**.
3. Tap **Nokia BPM**.

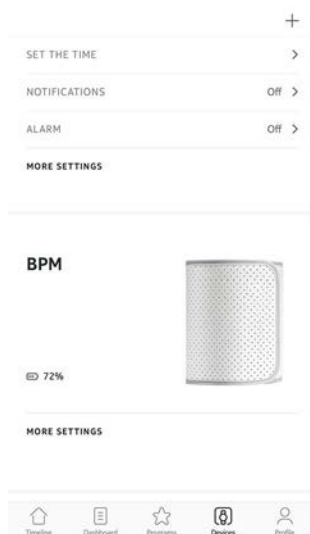

4. Tap **Dissociate**.
5. Tap **Remove from my account**.

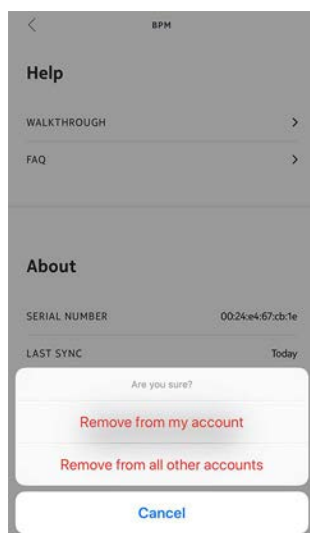

Cleaning my Nokia BPM

You can clean your Nokia BPM using a cloth dampened with water. Do not put the Nokia BPM's cuff in a washing machine or submerge it in water as it contains electronic components



Do not, under any circumstance, use any solvent to clean your Nokia BPM.

Changing the Batteries

To check the battery level of your Nokia BPM, perform the following steps:

1. Open the Nokia Health Mate® app.
2. Go to **Devices > Nokia BPM**.

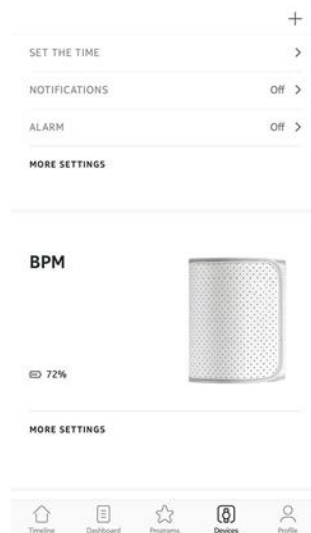

The battery level is displayed on the left.

If the battery level is below 20%, we advise that you change the batteries. Your Nokia BPM uses four 1.5 AAA alkaline batteries (LR3). To change the batteries of your Nokia BPM, perform the following steps:

1. Make sure the Wireless Blood Pressure Monitor is turned off.
If the LED is on, press the button for 3 seconds.
2. Turn the slot of the twist cover counterclockwise using a coin to remove the battery cover.
3. Replace the batteries.
Make sure the batteries are correctly inserted by following the polarity markings.
4. Put the cover back in place.

User Guide Copyright

This User guide is protected by Intellectual Property laws and copyright. Any reproduction, modification, representation, and/or publication without Nokia® prior approval is strictly prohibited. You may print this User Guide for your personal use exclusively.

For any questions, please contact Nokia® at: <http://nokia.ly/HealthSupport>.

Legal Notice



By using your Nokia BPM you expressly agree to the Nokia Services Terms and Conditions available on our [website](#).

Medical Device

- The Nokia BPM is a medical device and has been validated by competent authorities.
- The Nokia Health Mate® app is not a medical device. Any advice or insight given by the app cannot replace medical attention.

Personal Data

- Make sure you have read our privacy policy, which you can find on our [website](#).
- Make sure your Nokia® account password is secure enough to restrict access to your account. It should be at least eight-character long, have mixed case, and use a combination of alphanumeric and special characters.

Safety Instructions

Use and Storage

- Use the product at temperatures between 10°C and 40°C (50°F and 104°F).
- Product may be stored in a clean, dry location between -25°C and 55°C (-13°F and 131°F) when not in use.
- Remove the batteries if you do not plan to use your Nokia BPM for an extended period of time.
- The Nokia BPM is only meant to track your blood pressure and heart rate measurements, exclusively by wrapping it around your arm. Any other use is prohibited.

Safety

- Make sure you consult a doctor should the symptoms be persistent or worrying in any way.
- Do not allow your Nokia BPM to come in contact with liquids. If it gets wet, make sure you let it dry before trying to use it.
- Do not leave your Nokia BPM exposed to dust or sunlight for too long as it might damage the product.
- Keep your Nokia BPM and its accessories out of reach from children, as it contains small parts and may present a choking hazard.

Service and Maintenance

- Do not attempt to repair or modify your Nokia BPM on your own.
- If you have any issue, feel free to contact our Customer Service at: <http://nokia.ly/HealthSupport>.

Specifications

Nokia BPM

- Length: 150 mm (5.9 in.)
- Width: 140 mm (5.5 in.)
- Weight: 600 g (1.322 lbs) without batteries
- Cuff circumference: fits arm circumferences 22 to 42 cm (9 to 17 in)

Connectivity

- Wi-Fi 2.4 GHz 802.11 b/g/n
- Bluetooth Smart Ready

Technology

- Cuff oscillo metric method
- Measurement range: 0 to 285 mmHg
- Accuracy: ± 3 mmHg or 2% of reading
- Inflation: automatic inflation
- Controlled release

Metrics

- Heart rate measurement range: from 40 to 180 beats per minute
- Accuracy: 5% of reading

Battery life

- One year with four AAA (LR03) batteries

Compatible devices

- iPhone (4 and above)
- iPod Touch (4th generation or higher)
- iPad (2nd generation or higher)

Compatible OS

- iOS 7.0 or higher
- Android 4.0 or higher

App

- Nokia Health Mate® App

Document Release Overview

Release date		Modifications
April 2017	v1.0	First release
January 2018	v2.0	Nokia graphic chart
June 2018	v3.0	Screenshots update



The screenshots in this manual are used for explanatory purposes. Your actual screens may differ from the screenshots in this manual.

Warranty

Nokia® One (1) Year Limited Warranty - Nokia BPM

Nokia® warrants the Nokia® branded hardware product "Nokia BPM" against defects in materials and workmanship when used normally in accordance with Nokia®'s published guidelines for a period of ONE (1) YEAR from the date of original retail purchase by the end-user purchaser ("Warranty Period"). Nokia®'s published guidelines include but are not limited to information contained in technical specifications, safety instructions or quick start guide. Nokia® does not warrant that the operation of the Nokia BPM will be uninterrupted or error-free. Nokia® is not responsible for damage arising from failure to follow instructions relating to the Nokia BPM's use.

Regulatory Statements

Federal Communications Commission (FCC) Statement

FCC ID: XNAWPM02

This device complies with Part 15 of the FCC Rules. This equipment complies with FCC radiation exposure limits set forth for an uncontrolled environment. End users must follow the specific operating instructions for satisfying RF exposure compliance. This transmitter must not be co-located or operated in conjunction with any other antenna or transmitter.

Operation is subject to the following two conditions:

- (1) This device may not cause harmful interference, and
- (2) This device must accept any interference received, including interference that may cause undesired operation.

This device complies with the R&TTE Directive 1999/5/CE.

A copy of the EU Declaration of Conformity is available online at <https://health.nokia.com/fr/en/compliance>.