

# Dimplex



CASTILLO CST20



ZAMORA ZAM20

1

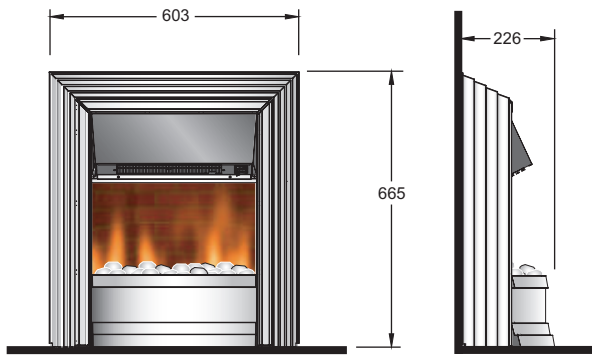

Castillo CST20

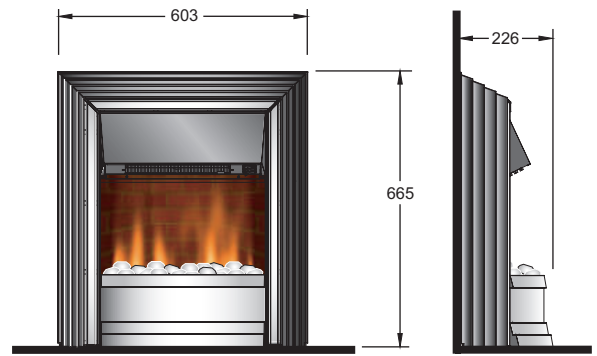

Zamora ZAM20

2

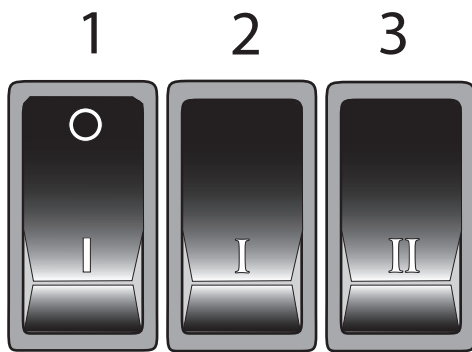

3

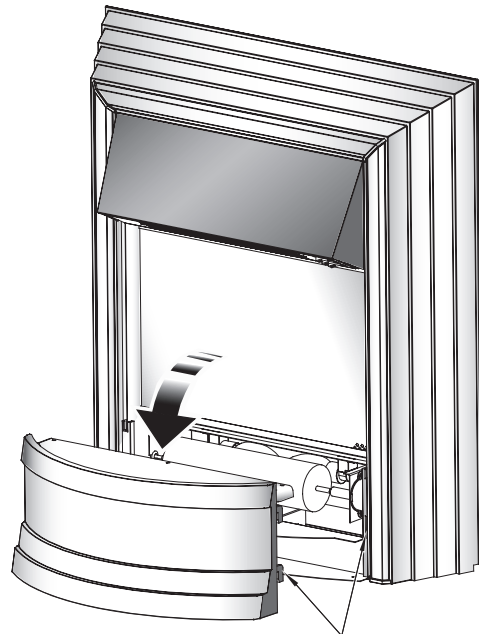

4

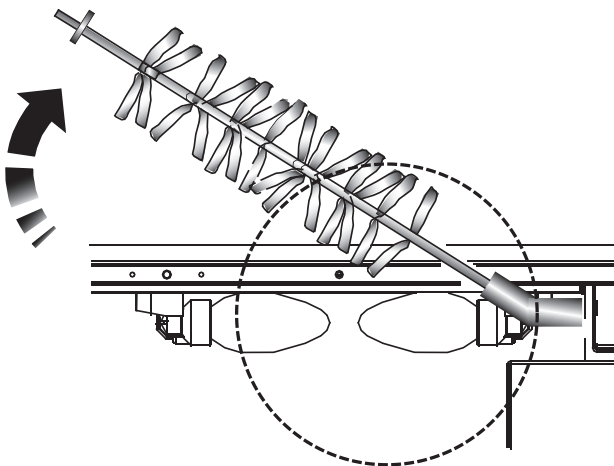

5

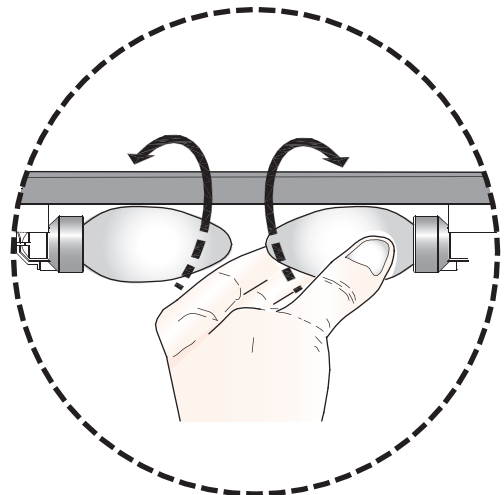

# Castillo CST20 & Zamora ZAM20

IMPORTANT: THESE INSTRUCTIONS SHOULD BE READ CAREFULLY AND RETAINED FOR FUTURE REFERENCE

## Important Safety Advice

When using electrical appliances, basic precautions should always be followed to reduce the risk of fire, electrical shock, and injury to persons, including the following:

If the appliance is damaged, check with the supplier before installation and operation.

Do not use outdoors.

Do not use in the immediate surroundings of a bath, shower or swimming pool.

Do not locate the heater immediately below a fixed socket outlet or connection box.

Do not cover the heater. Do not place material or garments on the heater, or obstruct the air circulation around the heater, for instance by curtains or furniture, as this could cause overheating and a fire risk.

This appliance is not intended for use by children or other persons without assistance or supervision if their physical, sensory or mental capabilities prevent them from using it safely. Children should be supervised to ensure that they do not play with the appliance.

Do not use this heater in series with a thermal control, a program controller, a timer or any other device that switches on the heat automatically, since a fire risk exists when the heater is accidentally covered or displaced.

Ensure that furniture, curtains or other combustible material are positioned no closer than 1 metre from the heater.

In the event of a fault unplug the heater.

Unplug the heater when not required for long periods.

Although this heater complies with safety standards, we do not recommend its use on deep pile carpets or on long hair type of rugs.

The appliance must be positioned so that the plug is accessible.

If the supply cord is damaged it must be replaced by the manufacturer or service agent or a similarly qualified person in order to avoid a hazard.

Keep the supply cord away from the front of the heater.

## General

Unpack the heater carefully and retain the packaging for possible future use, in the event of moving or returning the fire to your supplier. Loose coals and pebbles are packed separately within the carton. When the heater is assembled the coals or pebbles are placed on top of the fuel bed up to a maximum weight of 6kg.

The fire incorporates a flame effect, which can be used with or without heating, so that the comforting effect may be enjoyed at any time of the year. Using the flame effect on its own only requires little electricity.

These models are designed to be free standing and are normally positioned against a wall.

Before connecting the heater check that the supply voltage is the same as that stated on the heater.

Please note: Used in an environment where background noise is very low, it may be possible to hear a sound which is related to the operation of the flame effect. This is normal and should not be a cause for concern.

## Electrical connection

**WARNING – THIS APPLIANCE MUST BE EARTHED.**

This heater must be used on an AC ~ supply only and the voltage marked on the heater must correspond to the supply voltage.

Before switching on, please read the safety warnings and operating Instructions.

## Controls - see Fig. 2

Three switches provide a choice of heat settings. A switch is in the ON position when the side with the markings on (i.e. I, II, or III) is pushed in.

**Switch 1 (I)** Controls the electricity supply to the heater and flame effect.

Note: This switch must be in the ON (I) position for heater to operate with or without heat.

**Switch 2 (II)** Provides 1kW heat output

**Switch 3 (III)** Provides 2kW heat output with switch 2

## Thermal Safety Cut-out

A thermal safety cut-out is incorporated in the heater to prevent damage due to overheating. This can happen if the heat outlet was restricted in any way. The heater will switch on once the obstruction has been removed and the heater has cooled. If the cut-out continues to operate intermittently, the heater should be switched off and a service agent contacted.

## Maintenance

**WARNING: ALWAYS DISCONNECT FROM THE POWER SUPPLY BEFORE ATTEMPTING ANY MAINTENANCE.**

## Lamp Replacement - see Fig.'s 3, 4 & 5

There are two lamps located beneath the fuel effect. To gain access to the lamps, remove the coal/pebbles and place in a container. Remove the front fret/fuel effect from the fire by lifting it up and out from the slots on the fire - see Fig. 3.

Remove the rotisserie by carefully sliding the rubber connector off the motor shaft - see Fig. 4.

Remove the defective lamp by unscrewing it as shown in Fig. 5.

Replace with a 60W E14 SES Clear Candle lamp. Take care not to over-tighten the lamp.

Refit the front fret/fuel effect and replace the coal/pebbles.

## Recycling



For electrical products sold within the European Community.

At the end of the electrical products useful life it should not be disposed of with household waste. Please recycle where facilities exist. Check with your Local Authority or retailer for recycling advice in your country.

## Cleaning

**WARNING – ALWAYS DISCONNECT FROM THE POWER SUPPLY BEFORE CLEANING THE HEATER.**

For general cleaning use a soft clean duster – never use abrasive cleaners. The glass viewing screen should be cleaned carefully with a soft cloth. DO NOT use proprietary glass cleaners.

To remove any accumulation of dust or fluff the soft brush attachment of a vacuum cleaner should occasionally be used to clean the outlet grille of the fan heater.

## After Sales Service

Your product is guaranteed for one year from the date of purchase.

Within this period, we undertake to repair or exchange this product free of charge (excluding lamps & subject to availability) provided it has been installed and operated in accordance with these instructions.

Your rights under this guarantee are additional to your statutory rights, which in turn are not affected by this guarantee.

Should you require after sales service you should contact our customer services help desk on 0870 727 0101. It would assist us if you can quote the model number, series, date of purchase, and nature of the fault at the time of your call. The customer services help desk will also be able to advise you should you need to purchase any spares.

Please do not return a faulty product to us in the first instance as this may result in loss or damage and delay in providing you with a satisfactory service.

Please retain your receipt as proof of purchase.

 The product complies with the European Safety Standards EN60335-2-30 and the European Standard Electromagnetic Compatibility (EMC) EN55014, EN60555-2 and EN60555-3 which cover the essential requirements of EEC Directives 73/23 and 89/336

---

Glen Dimplex UK Limited  
Millbrook House  
Grange Drive  
Hedge End  
Southampton  
Hampshire. SO30 2DF

UK customer help line (8.00AM – 6.00PM Mon-Fri; 8.30AM-1.00PM Sat)

Customer Services:	Tel.	0870 7270101
	Fax.	0870 7270102
	e-mail	<a href="mailto:customer.services@glendimplex.com">customer.services@glendimplex.com</a>
Republic of Ireland	Tel.	01 8424833